

**1** Insert handle from right side and attach handle onto master shaft. Then insert knob set and tighten the handle.

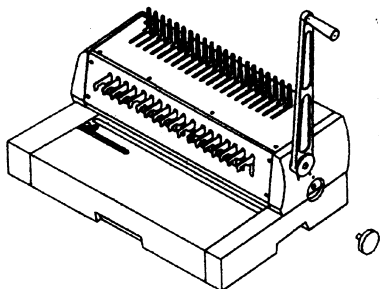

**3** 1. Adjust side guide.  
2. Pull set pin out to cancel this die if you find edge of document partially covers one of white rectangles on the alignment scale.  
3. Adjust knob for binding depth to 1, 2, 3, or 4.

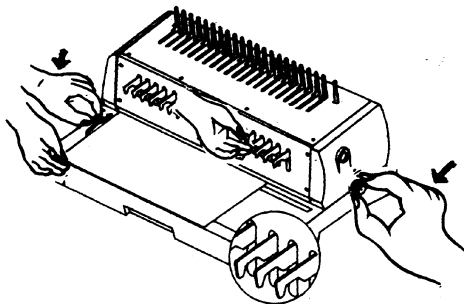

**5** Place ring with opening side up behind metal finger.

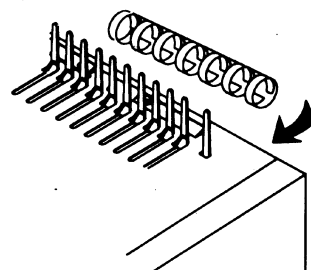

**7** Insert papers vertically and make sure all fingers are line up with punched holes lay down papers horizontally. Continue this step until all papers are bound.

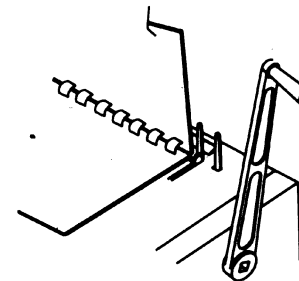

**2** Measure the thickness of papers to be bound and determine punching depth by using binding gauge. Select correct diameter of binding comb to use.

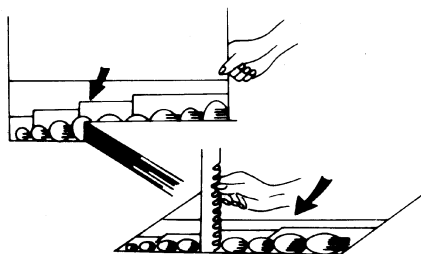

**4** Insert paper into punch throat. pull handle down to punch. Return handle to upright and pull paper out. Continue this step until all papers are punched.

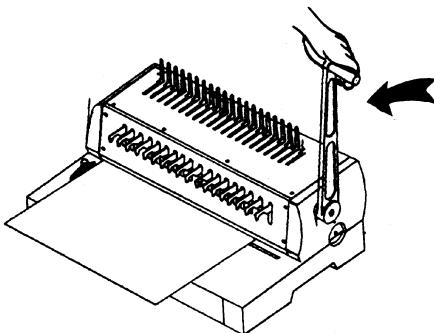

**6** 1. The binder stop is on the left hand side turn it down forward to the extreme end.  
2. Push the Master Arm forward until the proper opening of binding is reached. Hold it there.  
3. Turn the Binder Stop back until it locks. Fix it there.

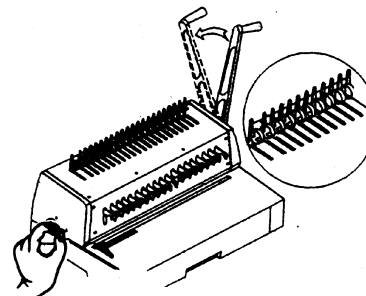

**8** Return handle to upright remove book from metal fingers. And you have a professionally bounded document.

